

AIR+PLUS

Air Conditioning Technologies



AIR+PLUS
Air Conditioning Technologies

Jet Axial Fan
&
Jet Fan

2



AIR+PLUS

Air Conditioning Technologies



Plug & Play

"Generates Satisfaction,,

JET – AXIAL FAN CATALOGUE

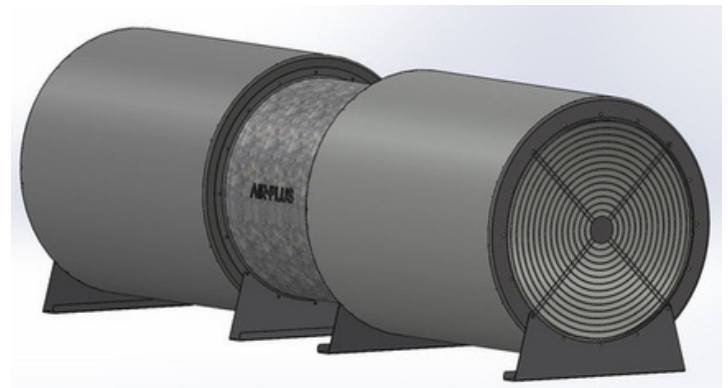

Table of Contents

Company Introduction.....	2
AIRPLUS Fan Selection Programme.....	2
Jet Fan.....	3
System Introduction.....	3
Benefits of the AIRPLUS Jet Fan System.....	4
AIRPLUS Jet Fan Design Criteria.....	4
AIRPLUS Jet Fan Design Processes.....	7
CFD Analysis Report.....	11
Technical Data.....	12
Automation Solutions.....	13
Technical Service.....	13
Field Test and Commissioning.....	13
Practical Information.....	14
Accessories.....	15
Axial Fan.....	16
System Description.....	16
Design Criteria of AIRPLUS Axial Fans.....	16
Technical Data.....	17
Capacity Table.....	17
Dimension Table.....	17
AP-AF 500 Technical Data.....	18
AP-AF 560 Technical Data.....	19
AP-AF 630 Technical Data.....	20
AP-AF 710 Technical Data.....	21
AP-AF 800 Technical Data.....	22
AP-AF 900 Technical Data.....	23
AP-AF 1000 Technical Data.....	24
AP-AF 1120 Technical Data.....	25
AP-AF 1250 Technical Data.....	26
Axial Fan Accessories.....	27
Protective Wire Cage.....	27
Control Panel.....	27
Emergency Power Cut-Off Switch.....	27
Frequency Inverter.....	27

Founded in 2007 with 100% Turkish capital in Istanbul, Airplus produces innovative, energy efficient, user and environmentally friendly products. Self-managing smart air conditioning units, which do not require any intervention by the end user, constitute the company's wide product range. The production facility is located on 7850 square meters of 9000 square meters of land. In this, the installation area, R&D, etc. Dec. sections there is also.

AIRPLUS Jet Fans with utility model patent and design registration are produced on the Jet Fan production line at the Istanbul Çekmeköy factory. Jet fan designs were designed by the AIRPLUS R&D team in Solidworks environment in 3D and flow analyses were performed decently in CFD environment. Design verifications were made in the test laboratory located in the AIRPLUS production plant. The jet fan production line is offered to its customers by going through the input quality control, process quality control and final quality control processes. Before delivery Run Tests are carried out in the factory environment on every Airplus jet fan produced. The quality control processes continue up to the point of testing and commissioning in the field. After completing the field tests and analyses, it is delivered to the customer.



Fan Selection Program

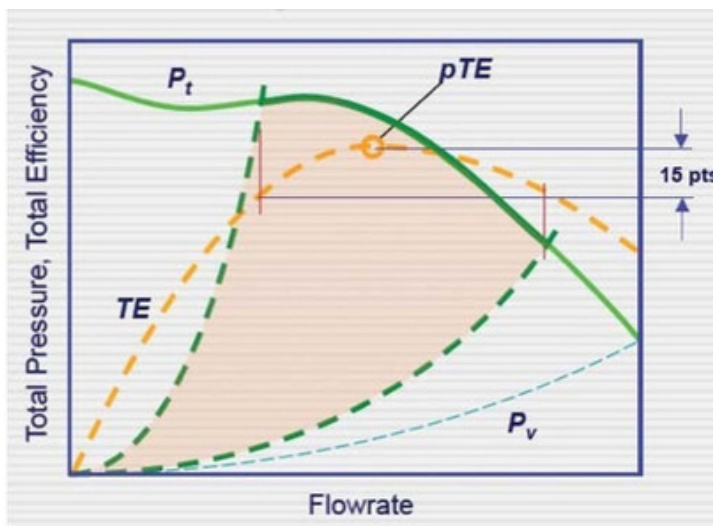

With AIRPLUS Fan Selection Programme, all fan groups produced can be selected.

Creation of wide-ranging technical outputs of selected products

Pricing of selected products

Creation of 2D and 3D technical drawings of selected products

Accessibility from anywhere on the web

Accessory selection operations can be performed.

The Airplus Jet Fan system is seen as a strong alternative to the traditional ducted ventilation systems used in indoor parking lots. This system has replaced conventional systems due to its application, operational and safety benefits. The designs of indoor car parks, whose daily use and need is increasing day by day, are designed by considering the ventilation system and fire prevention system. If the exhaust gases generated by the vehicles are not removed from the car park environment in sufficient level and time, it may cause headaches, eczema and even death in humans. These harmful gases and particles are ozone, nitrogen dioxide, carbon monoxide, benzene, benaprin, sulphur dioxide, lead. Their negative effects on human health; Nitrogen dioxide causes difficulty in breathing, bronchitis with prolonged exposure.

Carbon monoxide ; due to the decrease in the amount of oxygen in the blood, it causes deaths.

In order to create ventilated and safe areas in the parking lot, it is based on directing the polluted air and/or fire smoke in the environment to the main shafts where the exhaust fans are located with the induction effect created by jet fans instead of collecting them with a conventional ducted system.

According to conventional ducted type parking lot ventilation systems;

- There is no need to use ducts, grilles and supporting by-products.
- The flow reaction is much faster.
- Smoke control can be performed more precisely and safely.
- Ability to make more use of the height and space in the car park due to its structure to provide the opportunity.
- Installation, maintenance and operation are much easier and more economical.
- It offers a very effective solution during fire with full automation control.

It has advantages such as.

General Purposes of Jet Fan Usage;

- Preventing the accumulation of harmful gases (especially Carbon Monoxide) generated depending on the intensity of use of parking lots from the parking lot area.
- Directing the smoke that will be generated in the event of a fire to the main shafts, removing the smoke from the parking area quickly, providing safe escape areas in the parking area.
- Ensuring a more effective ventilation system by minimizing dead areas in the parking lot.
- It takes up much less space than conventional ventilation systems and provides more usable space in the parking lot.
- It needs lower electrical energy compared to conventional ventilation systems.
- Their maintenance and operation are easier and more economical compared to conventional air handling systems.
- It is easier to control and monitor when operated with full automation system.

Benefits of the AIRPLUS Jet Fan System;

Benefits in Terms of Initial Investment;

- Conventional ducted ventilation systems occupy large areas on the ceiling. Jet fans provide more usable space because they occupy much less space compared to them.
- The parking lot ensures that the area has a more ergonomic structure and an aesthetic appearance.
- It needs lower ceiling heights, so more parking floors can be provided for the same area.

Benefits in Terms Of Design;

- It does not need a conventional channel system, which is difficult to design, implement and operate.
- Virtual tests of ventilation and fire scenarios can be performed with CFD analysis, and account control can be performed before the application is started.
- The results are a more effective system.

Benefits for Operators;

- With the special 3-piece design, assembly can be performed easily and in a shorter time. Since the silencer sections are connected by a hinged system, electric motor and fan service can be provided without being disassembled.
- Since there is no need for an additional system, it can be installed independently from other installation works during application.
- There are no pressure losses in ducted systems during air movement. Due to this, the required electrical power is lower.
- The system is controlled by full automation. Energy savings can be achieved by operating the jet fans in the required areas and the CO sensors placed in parking lot area.
- It provides more efficient air circulation than conventional air ducted systems.

In case of fire, the safest way to reduce smoke and controlled removal of high temperature can be provided.

AIRPLUS Jet Fan Design Criteria

The ventilation of the jet fan and the desired in case of fire it is great to work completely under design conditions it is important. In order to achieve this, the wing design is of great importance. The blade structure used in AirPlus Jet fan systems has been developed by AIRPLUS R&D Team and has a design registration. Due to the aerodynamic structure of the wings, it provides high thrust and low noise level values can be achieved.

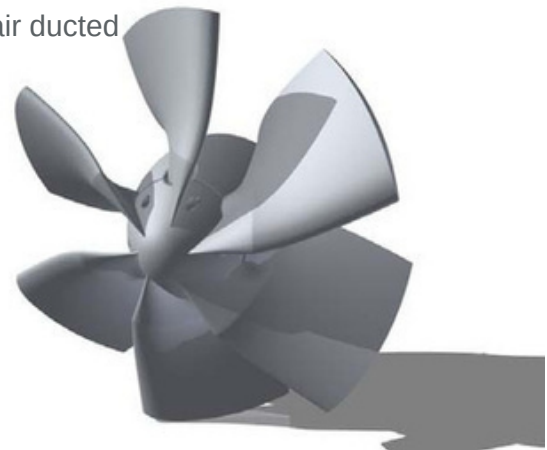

AIRPLUS Jet fan consists of 4 main components. These are;

- Wings
- Front Body
- Rear Body
- Shaft Slot

All components are designed with the aerodynamic flow of air in the foreground. The fact that the front body has a conical structure makes a positive contribution to the working efficiency of the fan. In this way, orientation is provided by moving on the fan blade and rear body surface without the flow line being interrupted.

Jet fans need to be hung on the parking lot ceilings due to their working structure. Due to these weights, they create a big problem for installation teams during application. In general jet fan designs, muffler sections and fan-engine sections are produced mounted on a single body. AIRPLUS Jet Fan 3 parts are produced as Front Muffler, Engine Fan Section and Rear Muffler section and can be installed separately on site.

The silencer sections are connected to the fan motor housing by a hinge system. When it is desired to service the fan motor part, there is no need to completely disassemble the device or silencers. With this application of the AIRPLUS Jet fan systems, which has a Patented Model, jet fan services can be performed very easily and quickly. With this superior feature, a great convenience and economical solution is offered to operators in technical services.

If there is an architectural difficulty for positioning of the jet fan, with the use of an elbow part 22,5-45-90, the air can be guided by degree angles. This application with a useful patent provides great flexibility during project design.

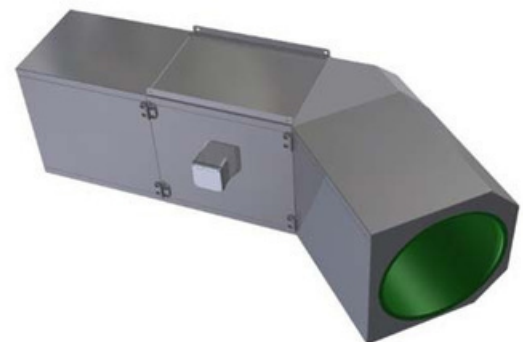
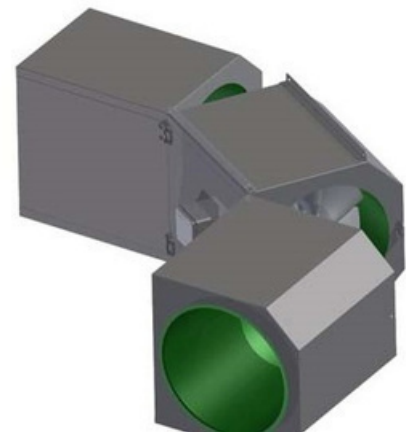
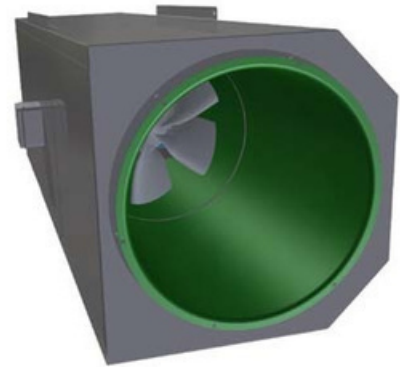

Application Types of AIRPLUS Jet Fan

The type of application where the air inlet and outlet are linear.

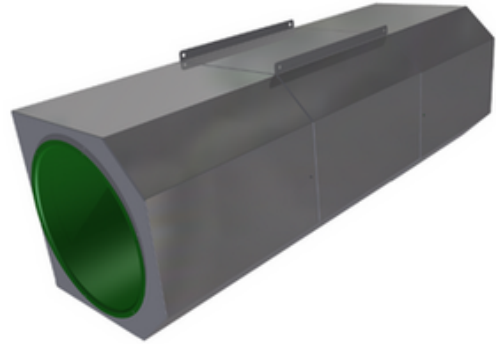

The type of application in which the air inlet can be set linearly and the outlet can be set to 22.5 ° - 45 ° - 90 °.

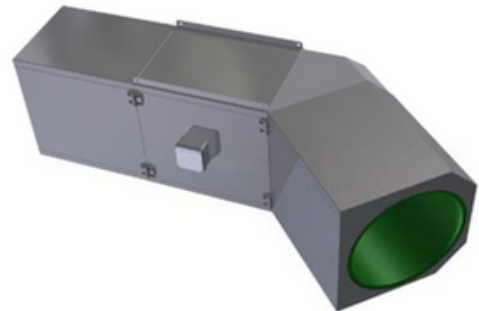

The type of application where the air inlet can be set to 22.5 ° - 45 ° - 90 °, the outlet to 22.5 ° - 45 ° - 90 °.

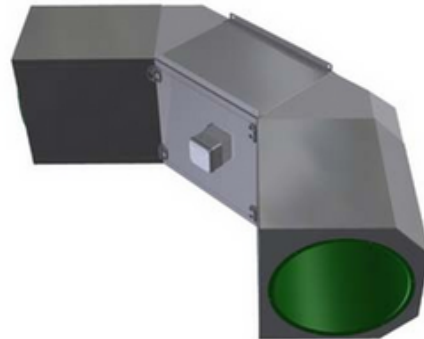

An application in which the air inlet and outlet are linear, and the silencer sections can be opened without being removed for easy access to the electric motor and fan.

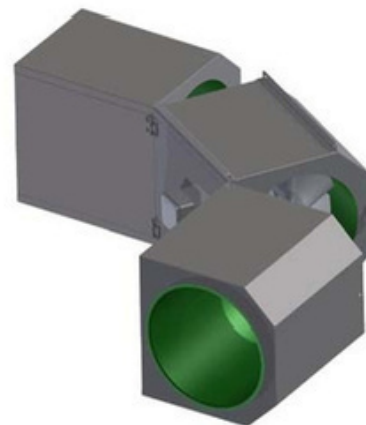

Making 3D designs of wing and body structures.



Performing static analyses under the flow and structural loads to be applied to the wing.

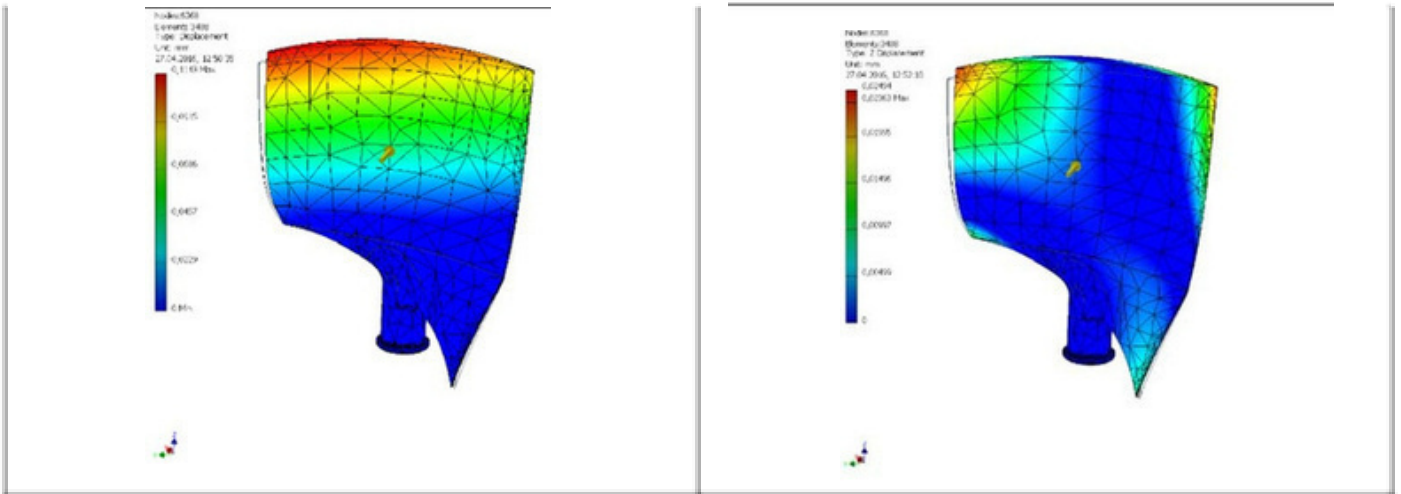

Performing static analyses under the flow and structural loads that will come over the front body used in the connection of the wings to the body.

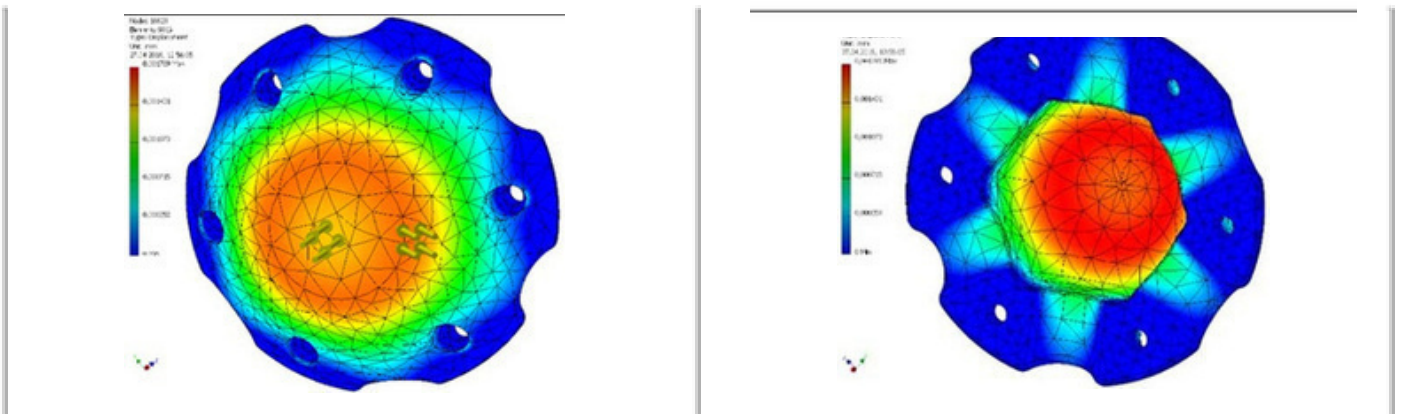

Performing static analyses under the flow and structural loads that will come over the rear body used in the connection of the wings to the body.

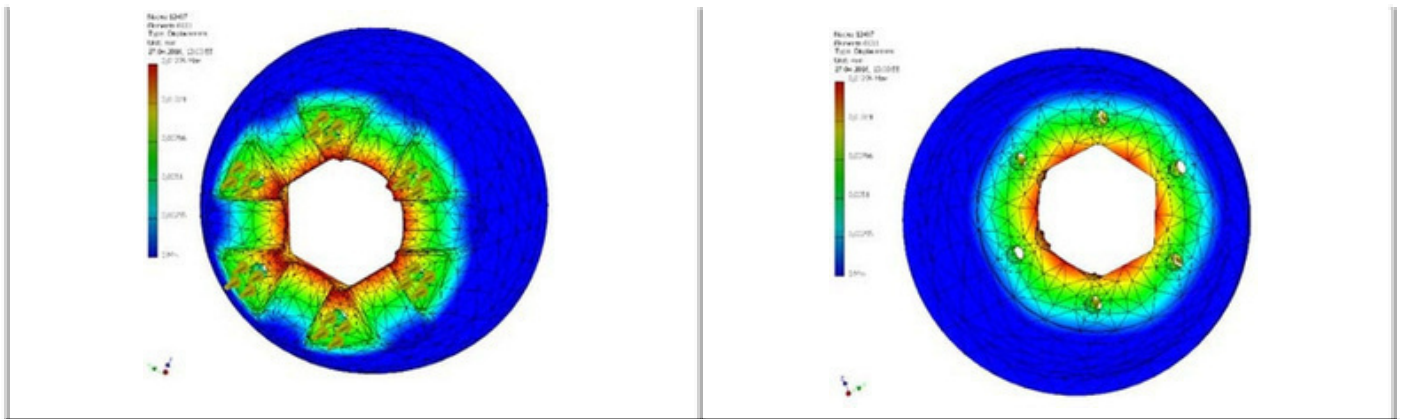

Performing stress analyses under the flow and structural loads that will come over the rear body used in the connection of the wings to the body.

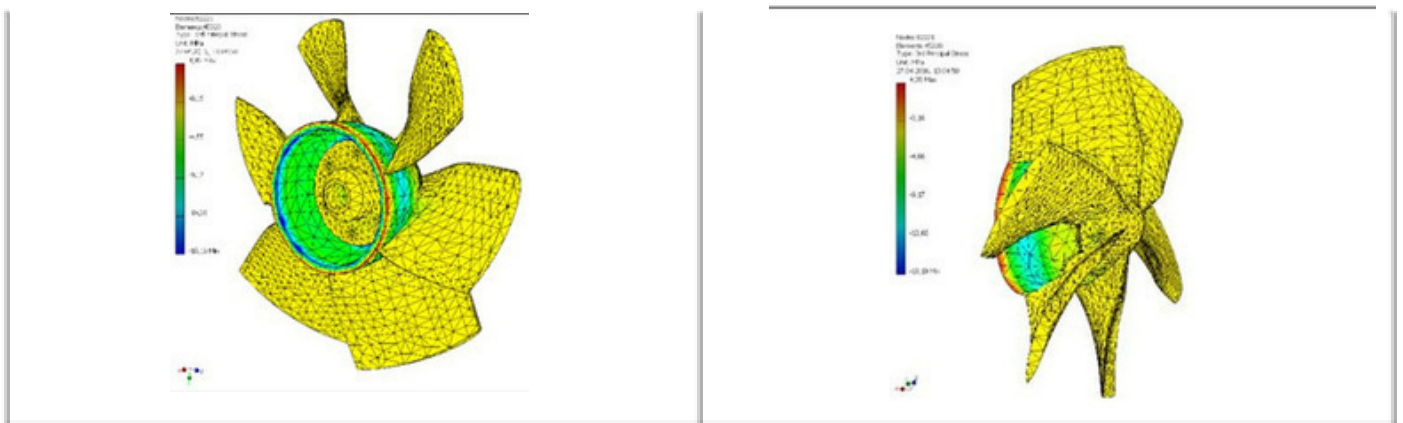

Performing stress analyses under the flow and structural loads that will come over the rear body used in the connection of the wings to the body.

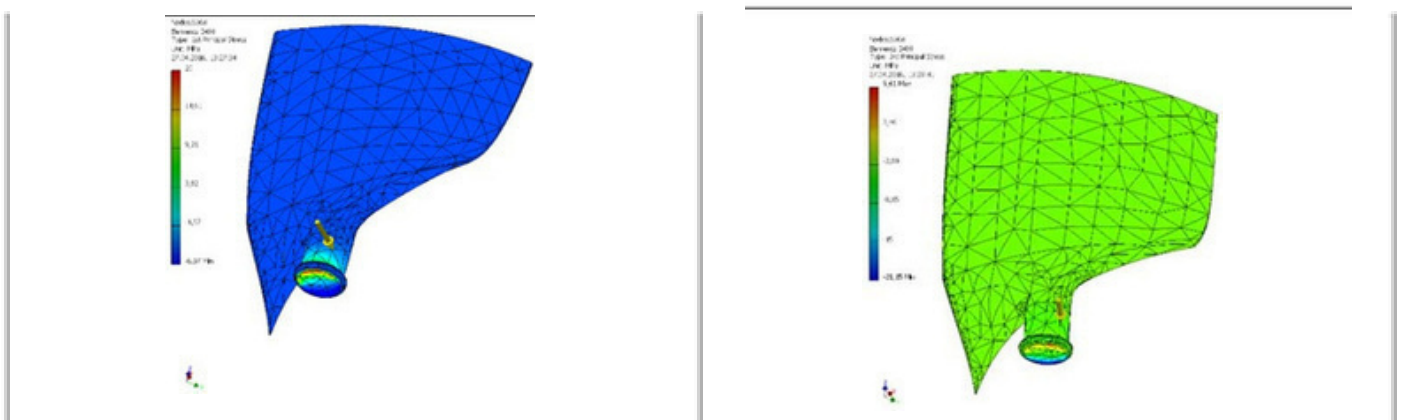

Making the jet fan body design in 3D and applying mesh for structural analysis.



Performing structural analyses of the force exerted on the jet fan sleeve under structural and flow loads.

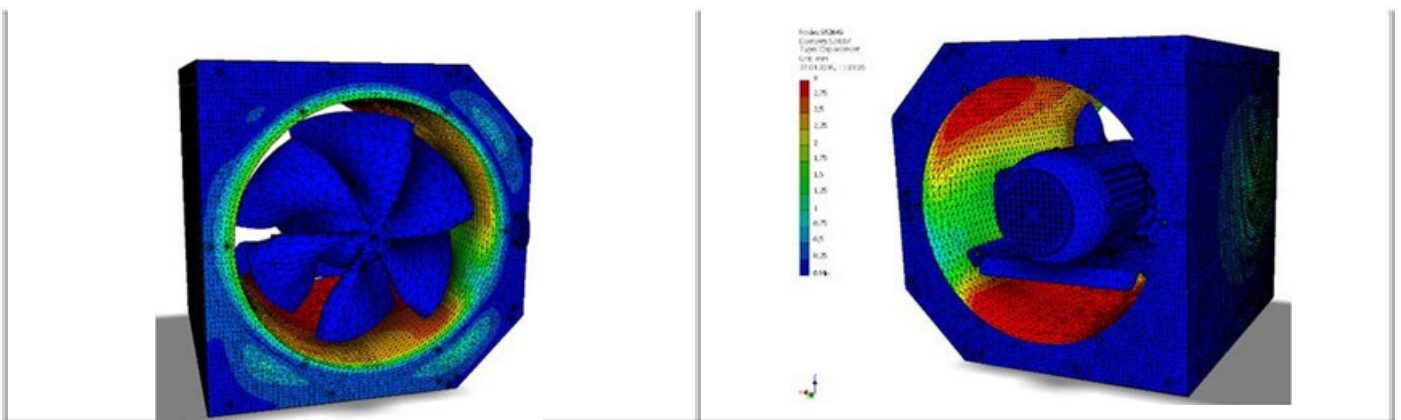

Performing structural analyses of the force that will come on the jet fan electric motor table under structural and flow loads.

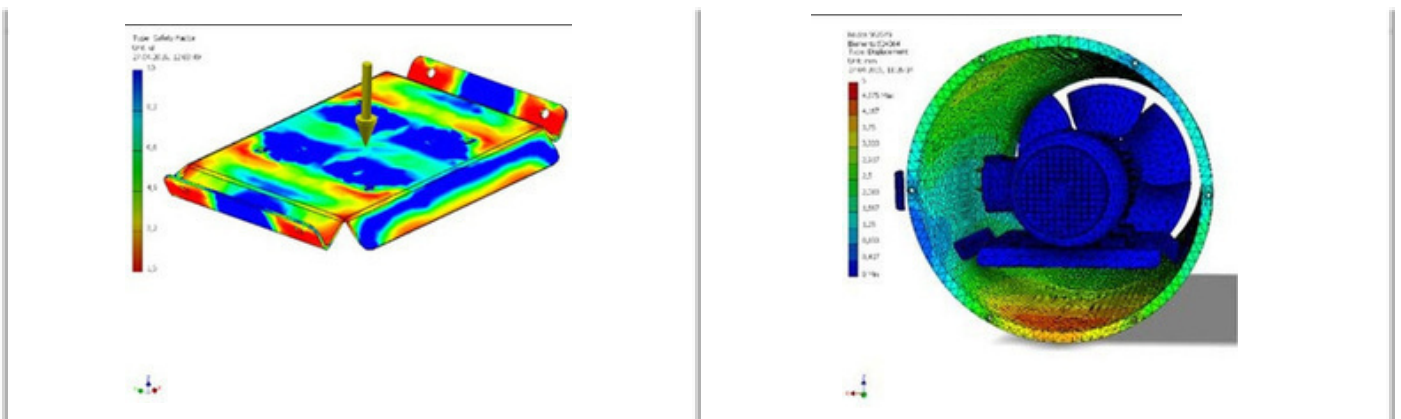

Performing structural analyses of the force that will be applied to the jet fan sleeve at the connection points under structural and flow loads.

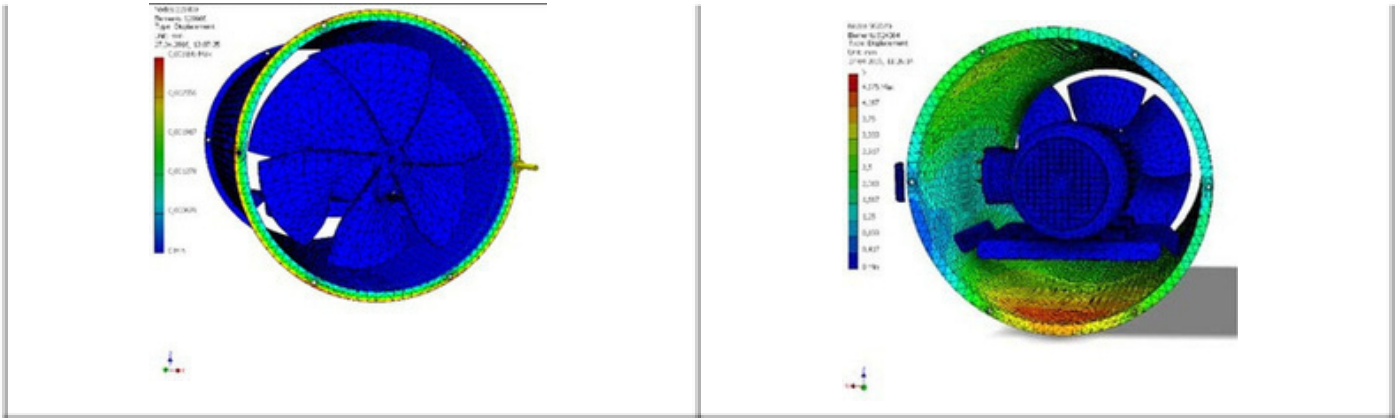

Performing structural analyses of the force that will come on the jet fan carcass structure under structural and flow loads.

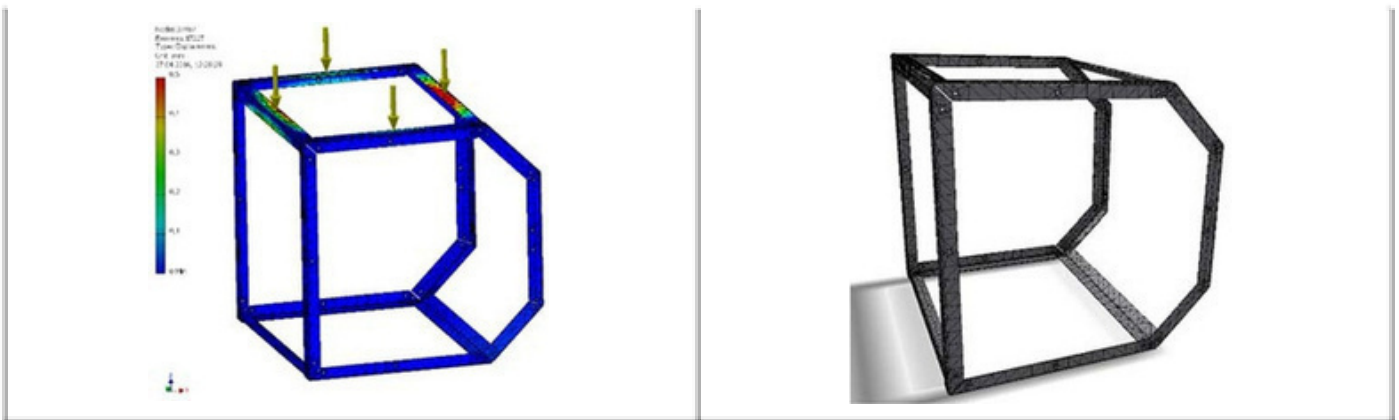

Performing structural analyses of the jet fan carcass structure under structural and flow loads that will come on it in the axial direction.

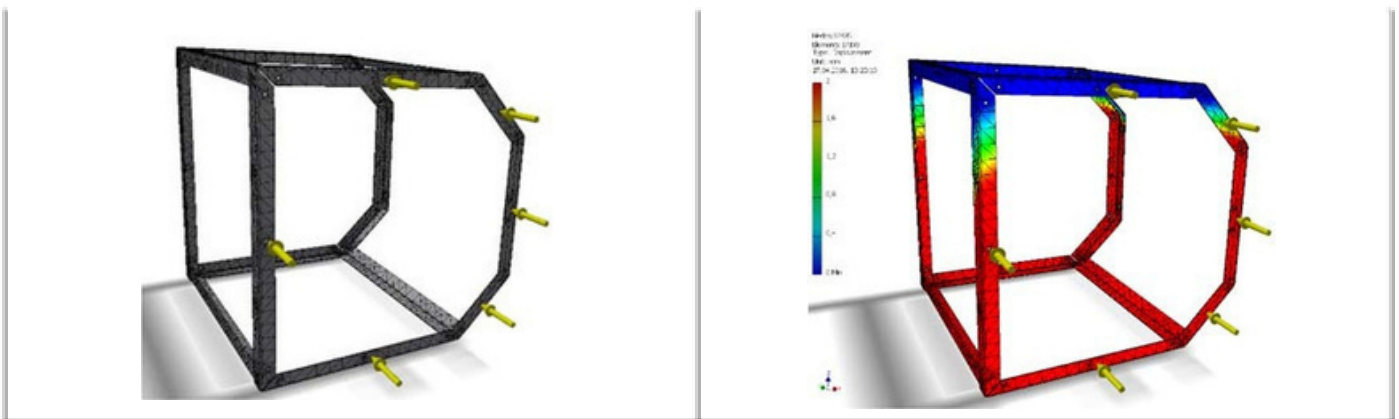

CFD ANALYSIS REPORT

It is difficult to predict where and how a fire will occur in jet fan systems. Therefore, it is necessary to calculate, analyze and test different probabilities. It is necessary to provide sufficient air movement in a homogeneous way to ensure the necessary air exchange in the parking lot area at the time of a fire. It is very important that this work is carried out at the project design stage both in terms of efficient operation of the system and minimizing the costs that will occur. For this reason, CFD (Computational Fluid Dynamics) studies are required for fire simulations in Jet fan systems and analysis of how the system will work most efficiently in this case.

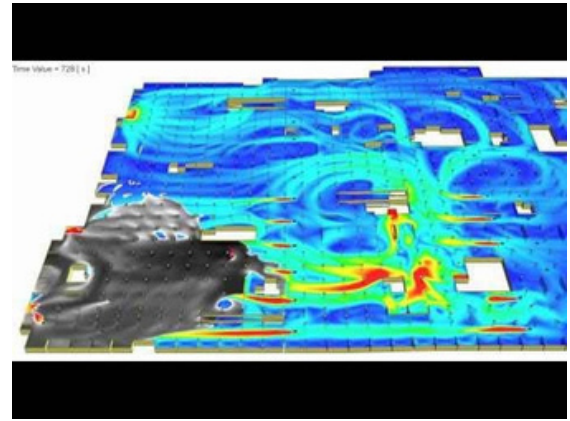

AIRPLUS is involved in both product development and project it carries out CFD studies with the R&D team in its analyses. It analyzes in such a way as to create at least 3 separate fire scenarios for each project and assigns the uninterrupted and most efficient operating points of the system.

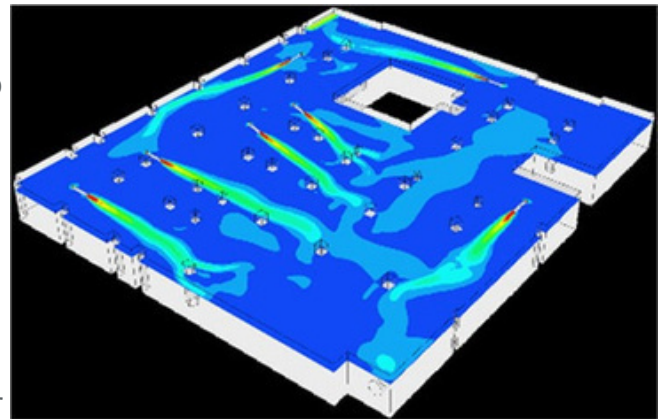

In these analyses;

- Whether the selected Jet Fan quantity and specifications are sufficient,
- Jet Fans are suitable according to the architectural structure of the parking lot whether it is placed,
- Whether air movements sufficient for adequate ventilation have been created in the event of a fire,
- Smoke density at a height of 1.5 m above the ground, the viewing distance and the movements of the air,
- Indoor temperature distribution in case of fire and determination of risky zones

we look for answers to these questions. In this way, it is ensured that the most efficient system is selected at the beginning of the project. It should be remembered that it is vital that Jet Fan systems operate continuously and effectively during a fire.

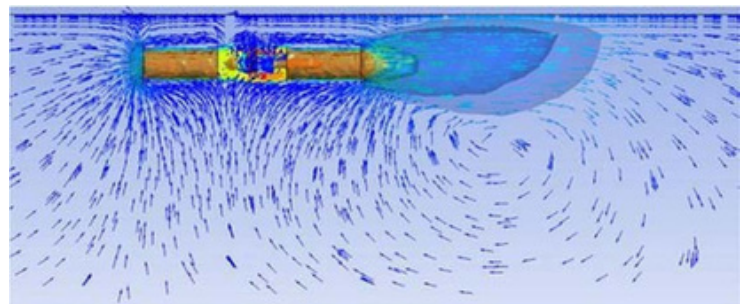
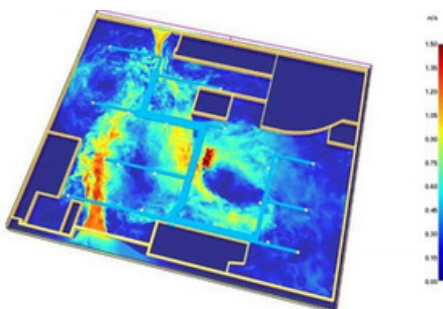

Technical Data

- Use for daily ventilation and smoke evacuation in case of fire.
- High thrust, low noise level with aerodynamically structured patented wing design.
- H insulation class IP55 motor in accordance with EN 60045-5/IEC 85.
- Special body design that allows the silencer and electric motor part to be mounted separately. With the hinged silencer compartment, it is possible to service the fan and motor parts without requiring disassembly.
- More silencer space, low sound level with patented body structure design.
- CE Certified
- Galvanized steel body.
- Maintenance Switch (Standard)
- Router Wing (optional)

Model	Thrust Force N	Air Flow Rate m ³ /h	Motor Power kW	R.P.M.	Sound Level LpA dB	Weight kg	Temperature resistance °C
AP-AJF-330-2	25	4800	0,4	2790	64	86	55
AP-AJF-330-2/4	25 / 6,3	4800/2100	0,4 / 0,1	2790/1450	64 / 48	86	55
AP-AJF-360-2	37	6400	0,9	2790	69	92	55
AP-AJF-360-2/4	37 / 9,1	6400 / 3000	0,9 / 0,1	2790/1450	69 / 51	92	55
AP-AJF-400-2	65	8150	1,6	2790	73	103	55
AP-AJF-400-2/4	65 / 13	8150 / 4150	1,6 / 0,2	2790 / 1450	73 / 55	103	55
AP-AJF-330-2	25	4800	0,4	2790	64	86	300 / 2 hours
AP-AJF-330-2/4	25 / 6,3	4800/2100	0,4 / 0,1	2790 / 1450	64 / 48	86	300 / 2 hours
AP-AJF-360-2	37	6400	0,9	2790	69	92	300 / 2 hours
AP-AJF-360-2/4	37 / 9,1	6400 / 3000	0,9 / 0,1	2790 / 1450	69 / 51	92	300 / 2 hours
AP-AJF-400-2	65	8150	1,6	2790	73	103	300 / 2 hours
AP-AJF-400-2/4	65 / 13	8150 / 4150	1,6 / 0,2	2790 / 1450	73 / 55	103	300 / 2 hours

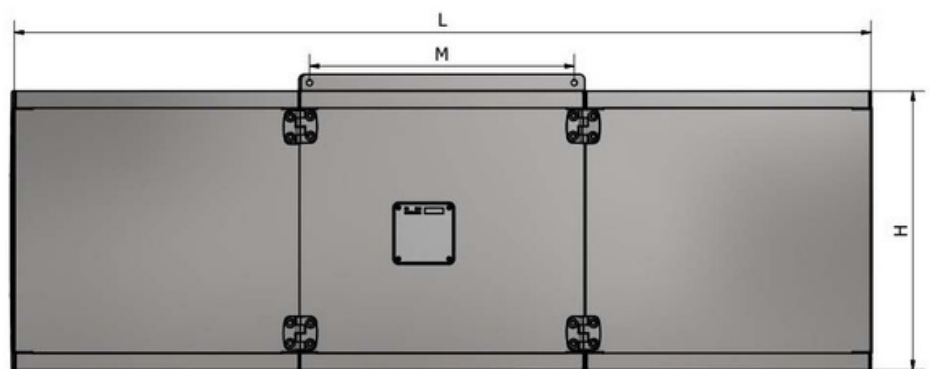
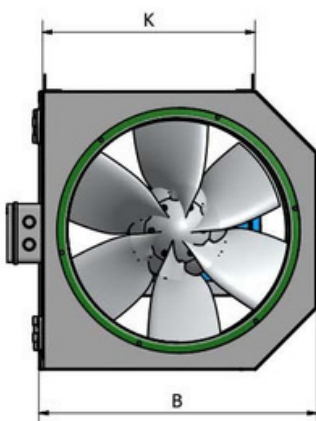

Model	L	H	B	K	M
AP-AJF-330	1350	435	430	325	245
AP-AJF-360	1400	465	460	355	295
AP-AJF-400	1530	495	490	385	345

*Dimensions are mm.

AIRPLUS Jet Fan systems automation solutions are designed for fan control, including fresh air and exhaust fans, jet fans, control dampers, smoke sensors for ventilation and smoke evacuation of parking areas.

The control scenario consists of two separate parts, daily ventilation and fire. In the daily ventilation scenario, it performs ambient ventilation according to the CO (carbon monoxide) ratio of the environment, time planning or information received from the BMS system. It is operated as a first stage or second stage according to the CO ratio.

In case of a fire scenario, it is activated by the information received from the smoke sensors. Performs the functions found in the specified fire scenario. It creates escape areas in different directions for smoke evacuation. For uninterrupted operation during a fire, all safety applications used for the normal operating conditions (Motor Overcurrent Protection) are disabled and the system remains in operation until the fans are destroyed. At this time, only the shaft dampers in the fire zone should switch from the open position to the closed position of the shaft dampers on the other floors. Otherwise, there is a risk that smoke will reach the other floors as well.



Technical Services

Jet fan applications combine many business disciplines that support each other decently. For this reason, the process leading up to testing and commissioning in the production of the product should be considered as a whole and evaluated within the discipline of project management.

AIRPLUS Technical Team is within the scope of its expertise in these processes;

- Preparation of project management plans and taking duties and responsibilities in relevant meetings,
- Creation of plans and business tasks of projects and phases,
- Preparation of all drawings required for the project in 2D or 3D,
- Preparation and reporting of CFD analyses with at least 2 alternatives,
- Creation of Control Matrices,
- Creation of all electricity and panel projects necessary for the system,
- Managing all shipment processes of products to the construction site.
- Management of all delivery processes of products to the construction site,
- Providing practical training to the relevant technical units about the products and the working principle of the system
- Providing regular maintenance services.

Field Tests and Commissioning

The AIRPLUS Technical team, after all the assembly operations have been completed then, under the supervision of the relevant business management, within the scenarios defined in the CFD Analysis reports, it performs smoke testing and design verification of those calculated in theory in practice.



Practical Information

jet fans are positioned in the range of 100 m²/piece - 500 m²/piece depending on the application plans and calculations. Depending on the information produced by CO (Carbon Monoxide) sensors placed in different numbers and locations, first the main collector axial fans and then the jet fans are activated and the environment is ventilated. According to the detected CO ratio, the speed of the fans is controlled, thus energy saving is ensured.

If the fire condition is detected according to the information received from the smoke sensors, CO sensors Without taking into account the information received, the fans in the system switch to continuous operation mode at full speed.

Jet Fans are designed and manufactured taking into account the thrust they produce. In a jet fan, the thrust is proportional to the amount of air mass it will carry and the speed it gives to this mass.

Ventilation systems in closed parking lots perform the functions of removing exhaust gases from vehicles in daily operation and providing escape areas for safe evacuation of people in case of fire and providing the necessary areas for fire crews to intervention.

Ventilation system according to British Building Regulations;;

- It should provide 6 air changes of the total parking lot volume in daily operation.
- For smoke evacuation, 10 air changes of the single floor parking lot volume should be provided in case of emergency.
- In a ventilation shaft, the total ventilation load should be divided into two equivalent fans 50% +50%.
- The fans should be able to operate at a minimum of 300 °C – 2 hours.
- 50% of the exhaust vents of ducted systems should exhaust from high (near the ceiling) levels and 50% from low (near the ground) levels.
- Attention should be paid to fresh air sources. If there is not enough natural fresh air intake, fresh air should be provided with the help of fans.

Example Calculation;

- The net volume is calculated using the net area of the parking lot and the height from the ground
- The total flow rate is calculated using the total net volume. Here, the cycle rate is selected as 10 changes taking into account the fire situation.
- The air flow cross sections are determined.
- There is a speed value to be formed in the air flow corridor.

$$v = \frac{Q_T}{3600 \times A_K}$$

Stroke area with jet fan;

$$S_p = \frac{4F}{\lambda \times \gamma \times v^2}$$

F : jet fan driving power (N),
 λ : cross - section constraction factor (0,8), γ : air density $(1,2 \frac{kg}{m^3})$, v : corridor speed of airflow $(\frac{m}{s})$

Parking

dimensions : 180 m x 100 m = 18.000 m²

Area to be extracted: $180 \text{ m} \times 10 \text{ m} = 1.800 \text{ m}^2$

Net Area = $18.000 - 1.800 = 16.200 \text{ m}^2$

Net Volume = $16.200 \text{ m}^2 \times 2.8 \text{ m} = 45.360 \text{ m}^3$

Total Airflow = $45.360 \times 10 = 453.600 \text{ m}^3/\text{h}$

Cross-section of airflow = $90 \times 2.8 = 252 \text{ m}^2$

Corridor speed of airflow = $453.600 / 3600 / 252 = 0,5 \text{ m/s}$

Selected jet fan : Stroke area for AP-JF-400 65 N = $(4 \times 65) / (0,8 \times 1,2 \times 0,5^2) = 1083 \text{ m}^2$
Total number of jet fans = $16.200 / 1083 = 14,95 = 15$ must be used.

Accessories Jet Fan Routing Part

In AIRPLUS Jet Fan systems with a Useful Patent, if the architect has a problem with the positioning of the jet fan, with the use of an elbow part 22,5 - 45 - 90 it provides the possibility of using it in 3 different locations to be graded.

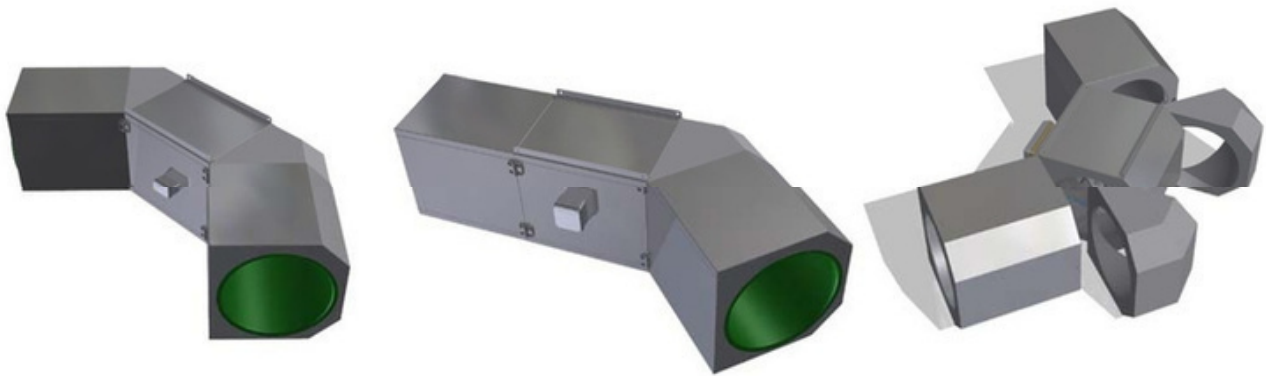

Router Wing

It is a router blade made of galvanized steel to direct the air flow. It can be used in all models.

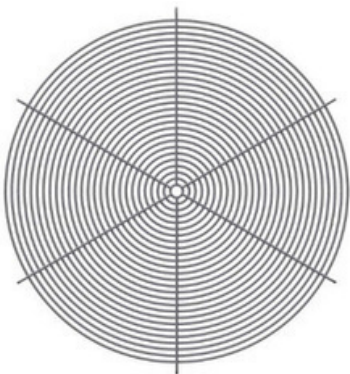

Protective Wire Mesh

It is used to prevent manual contact and unwanted parts from entering the fan.

AXIAL FAN

System Introduction

Axial fans are used in parking ventilation systems to remove polluted air generated in the environment or fire smoke during a fire, to provide fresh air needed by the parking lot if necessary.

Design Criteria of AIRPLUS Axial Fans

Thanks to the aerodynamic wing structures designed by the AIRPLUS R&D Team, high-efficiency AIRPLUS Axial Fans with low energy consumption fully meet the design criteria needed for parking lot ventilation.

It has the ability to mount the fan blades at different angles with its design, it can be provided to operate at wide flow and pressure ranges with the same diameter ranges.

AIRPLUS Axial Fans consist of four main components;

- Wings
- Front Body
- Rear Body
- Shaft Slot

Fan Cell;

AIRPLUS Axial Fans are manufactured with cells as standard it is provided. The cell body made of Aluzinc sheet metal provides structurally high strength and high resistance to corrosion.

Fan;

The fan hub and wings are made of cast aluminum it is provided. The entire system is designed according to EN12101-3 and it is suitable for working for 2 hours at a temperature of 300 °C.

Isolation;

Sound insulation is provided by using 70 kg/m3 density rock wool between the body and the fan sleeve.

Cell legs;

They are produced from hot dipped galvanized steel as standard. The fan has special transport cavities for horizontal and vertical transport on the construction site. .

Fan Sleeve;

It is produced from hot dip galvanised steel. It provides low sound level values thanks to its hollow structure on its surface.

The motor;

It has SO-H insulation class and is in IP 55 protection class. The terminal blocks used for power connection are made of ceramic material. The electricity supply is 380V/50Hz/3 phase.

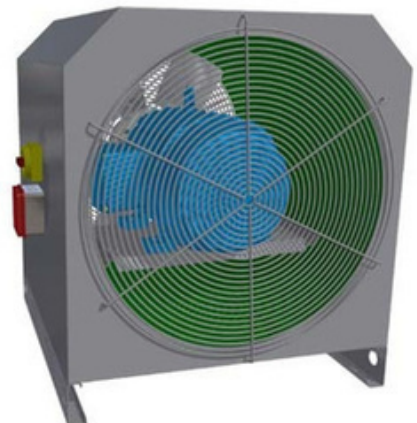

Technical Data
Capacity Table

Model	Number of Wings	Range of Wing Angle	kW / RPM	Airflow (min.- max.) (m ³ / h)	Sound power (dBA)
AP-AF 500	6	-8° / 8°	4 - 3000	4000 - 16000	102
AP-AF 560	6	-8° / 8°	15 - 3000	7500 - 27500	108
AP-AF 630	6	-8° / 8°	18,5 - 3000	7500 - 42000	114
AP-AF 710	6	-8° / 16°	5,5 - 1500	5000 - 35000	95
AP-AF 800	6	-8° / 12°	7,5 - 1500	5000 - 45000	99
AP-AF 900	9	-12° / 12°	15 - 1500	10000 - 70000	103
AP-AF 1000	9	-16° / 12°	30 - 1500	10000 - 90000	107
AP-AF 1120	9	-20° / 4°	37 - 1500	20000 - 125000	108
AP-AF 1250	9	-14° / 8°	55 - 1500	30000 - 140000	110

Dimension Table

Model	H	B	H1	L	ØD
AP-AF 500	560	565	100	665	500
AP-AF 560	670	675	100	725	560
AP-AF 630	740	745	100	815	630
AP-AF 710	820	825	100	895	710
AP-AF 800	910	915	100	985	800
AP-AF 900	1010	1015	100	1085	900
AP-AF 1000	1110	1115	100	1185	1000
AP-AF 1120	1230	1235	100	1305	1120
AP-AF 1250	1360	1365	100	1435	1250

*Dimensions are mm.

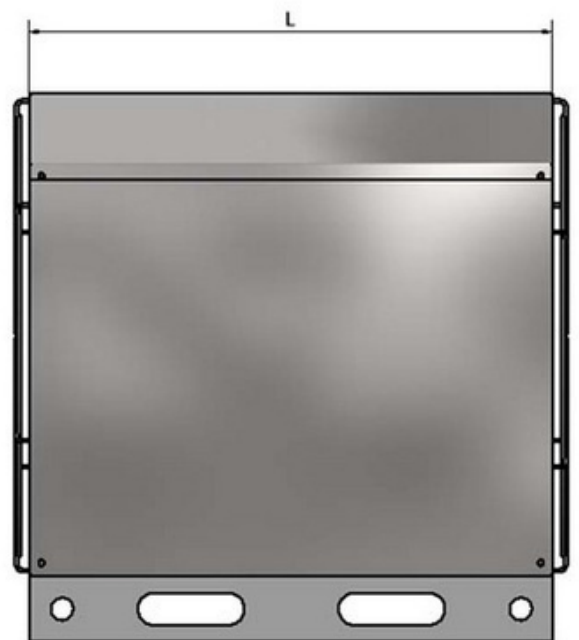
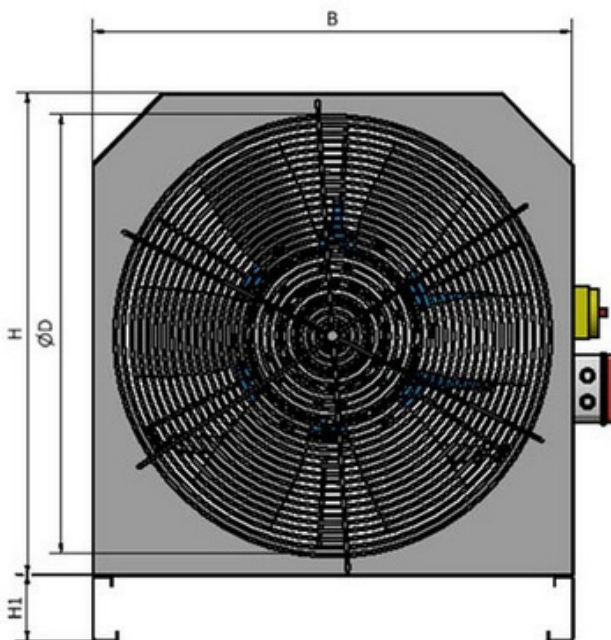

AP-AF 500 Technical Data

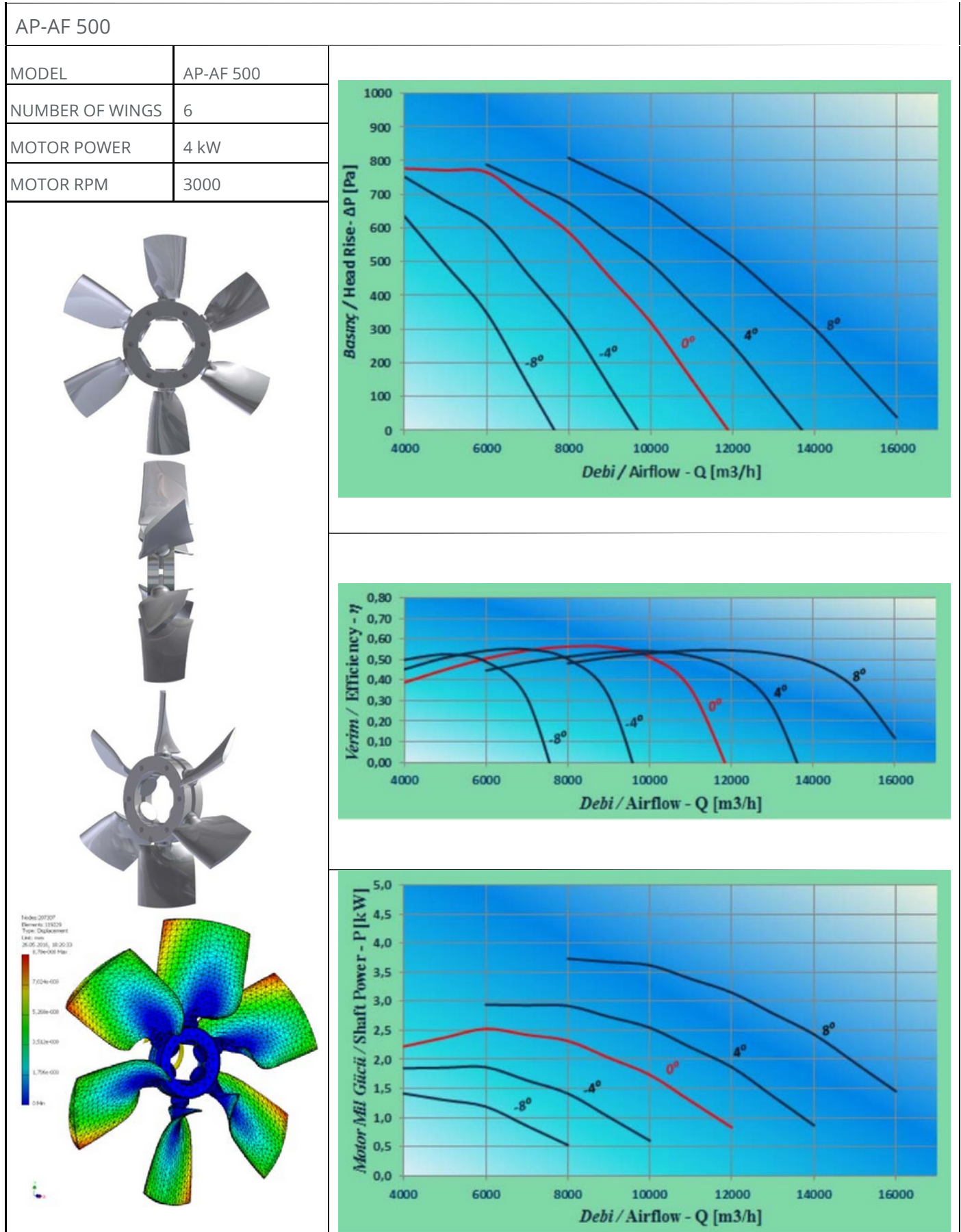

* ANSI/AMCA 210-07 standard is taken as reference in Fan Flow Performance tests.

* ISO 13347 standard was taken into account in the Noise Performance test.

AP-AF 560 Technical Data

AP-AF 560	
MODEL	AP-AF 560
NUMBER OF WINGS	6
MOTOR POWER	15 kW
MOTOR RPM	3000



Model: AP-AF 560
Element: 240123
Type: Displacement
Unit: mm
26.05.2016, 10:26:08
4,000e+008 Max

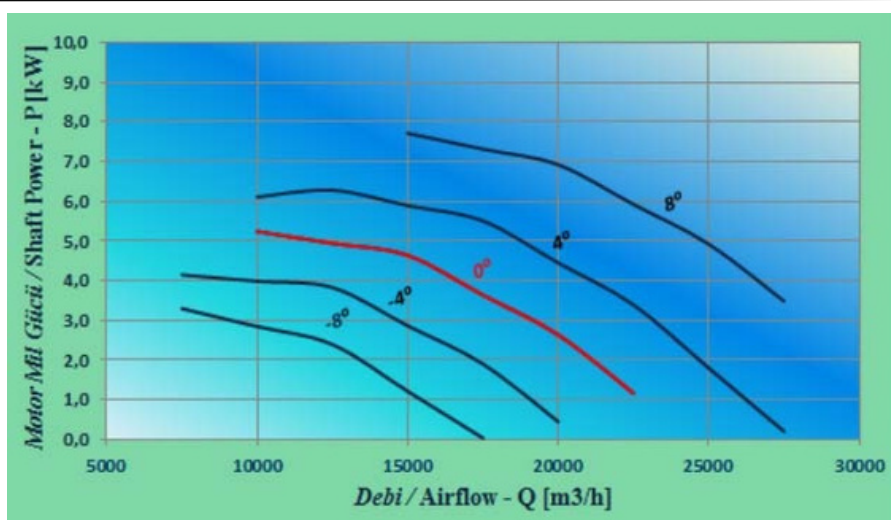
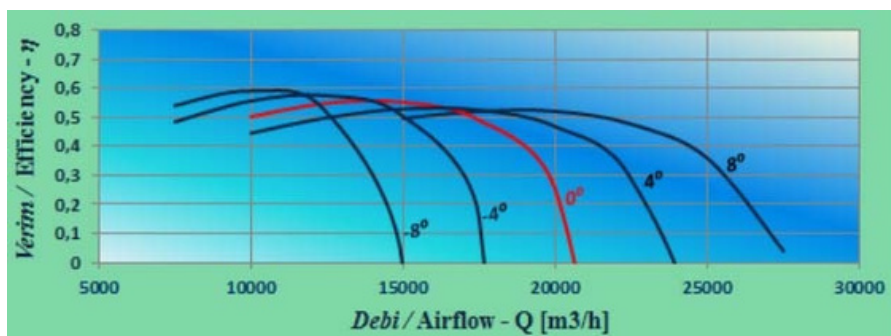
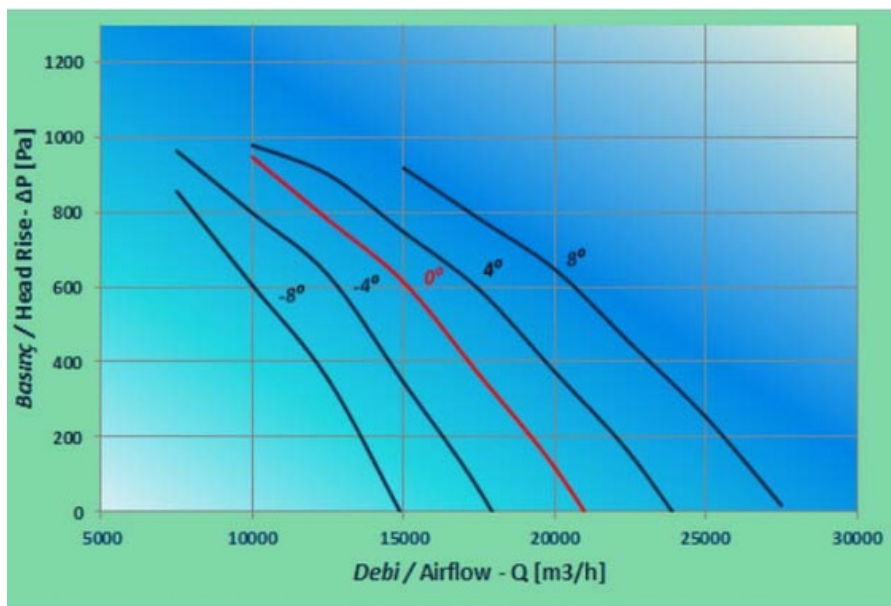
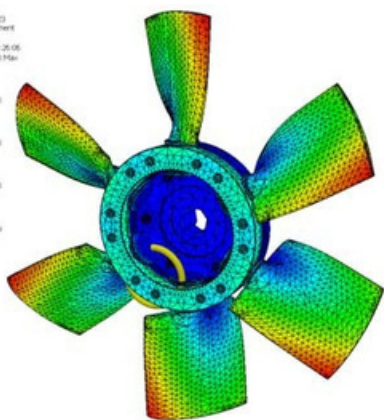
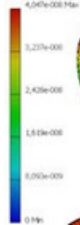

* ANSI/AMCA 210-07 standard is taken as reference in Fan Flow Performance tests.

* ISO 13347 standard was taken into account in the Noise Performance test.

AP-AF 630 Technical Data

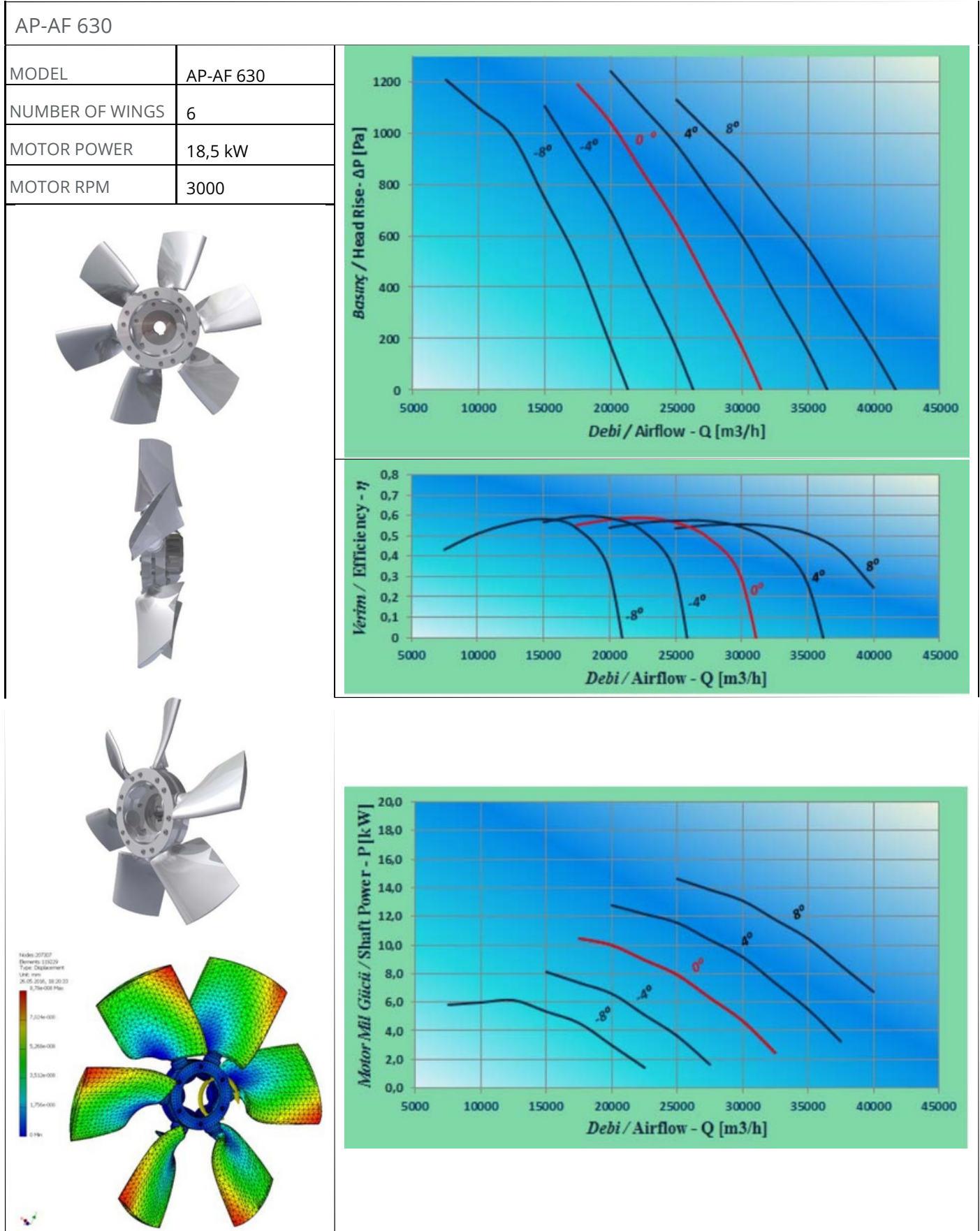

* ANSI/AMCA 210-07 standard is taken as reference in Fan Flow Performance tests.

* ISO 13347 standard was taken into account in the Noise Performance test.

AP-AF 710 Technical Data

AP-AF 710

MODEL	AP-AF 710
NUMBER OF WINGS	6
MOTOR POWER	5,5 kW
MOTOR RPM	1500



Model: 2027507
 Elements: 132029
 Total Displacement:
 26,45, 20,16, 50, 20,33
 6,79e+001 Mass

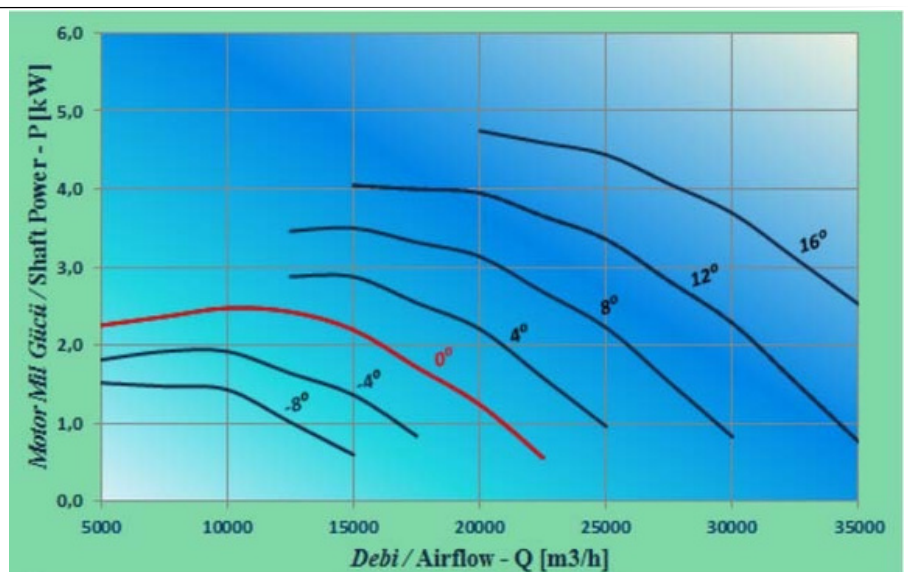
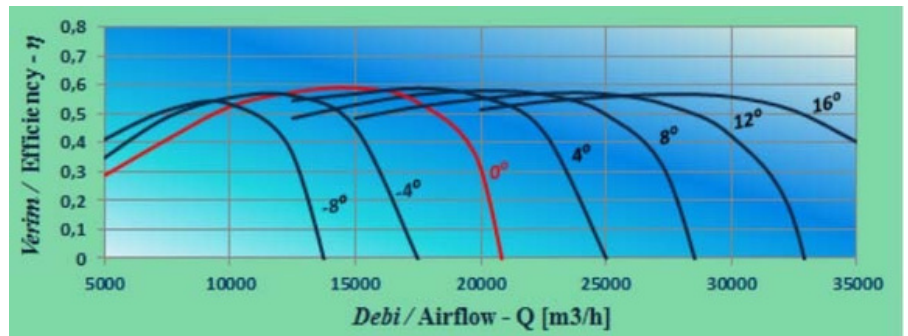
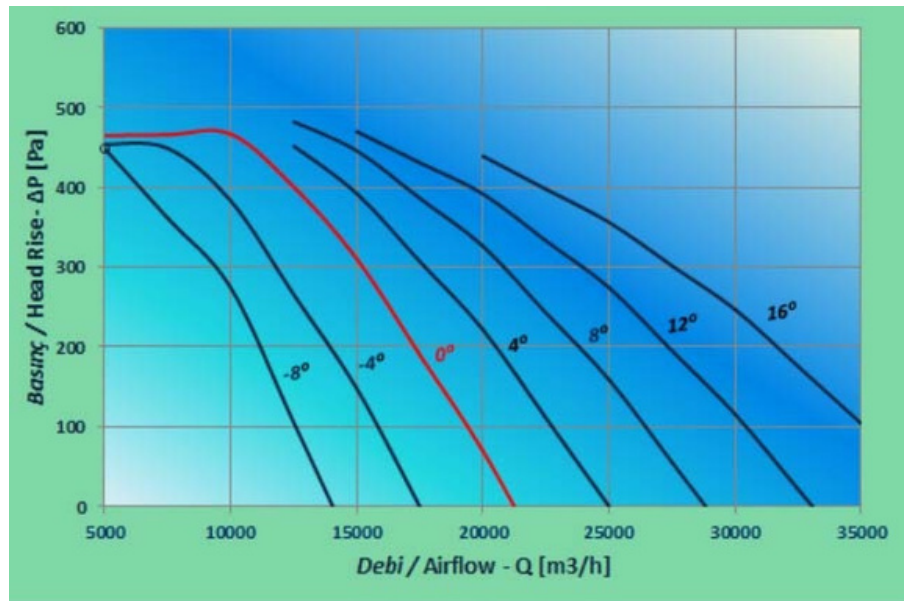
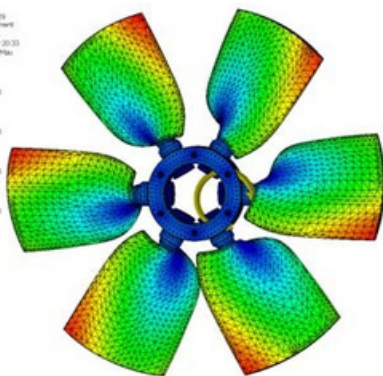
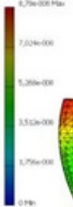

* ANSI/AMCA 210-07 standard is taken as reference in Fan Flow Performance tests.

* ISO 13347 standard was taken into account in the Noise Performance test.

AP-AF 800 Technical Data

AP-AF 800	
MODEL	AP-AF 800
NUMBER OF WINGS	6
MOTOR POWER	7,5 kW
MOTOR RPM	1500

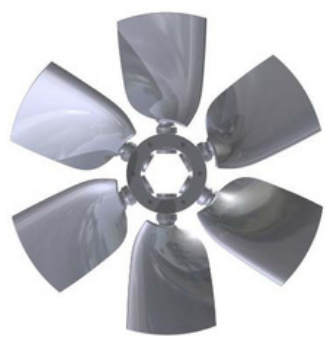

Model: 107907
 Geometry: 111029
 Type: Placement
 Unit: mm
 26.05.2016, 09:00:13
 0,7564028 Pa

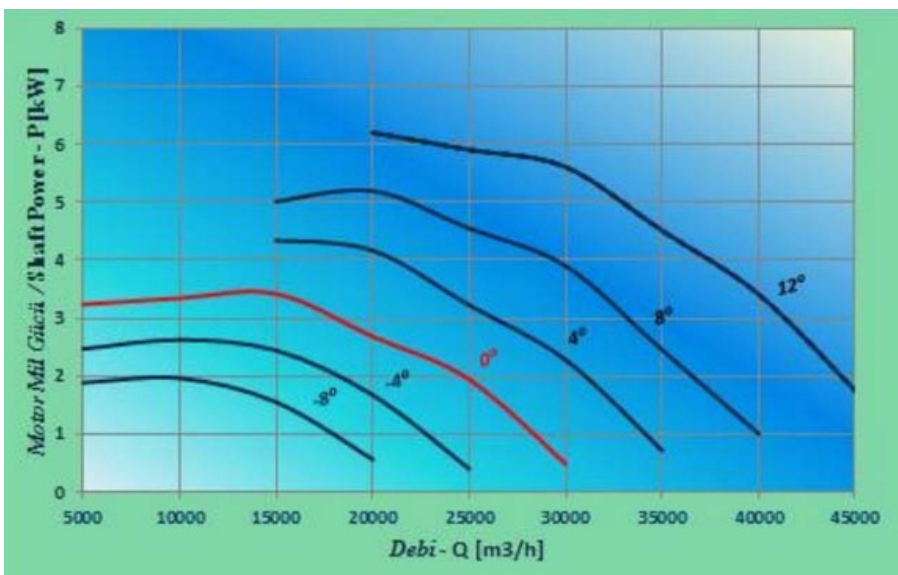
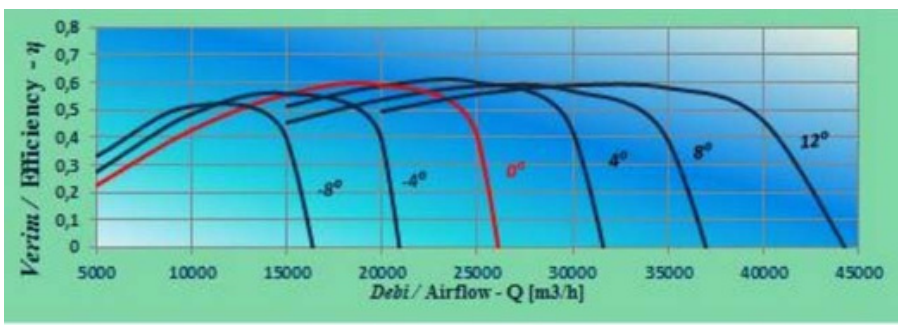
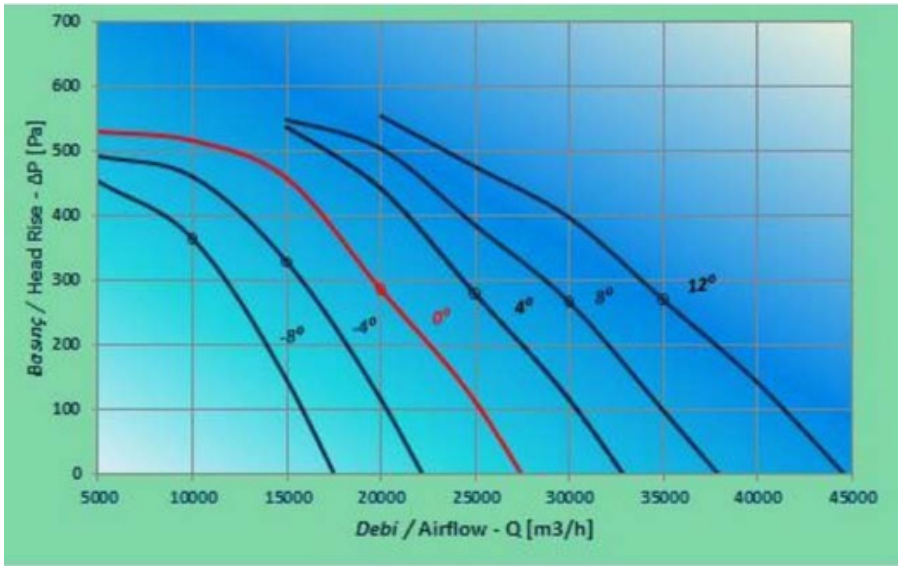
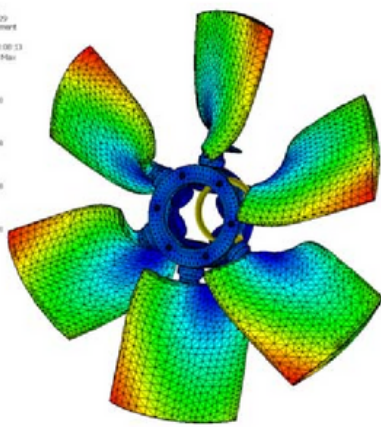

* ANSI/AMCA 210-07 standard is taken as reference in Fan Flow Performance tests.

* ISO 13347 standard was taken into account in the Noise Performance test.

AP-AF 900 Technical Data

AP-AF 900	
MODEL	AP-AF 900
NUMBER OF WINGS	9
MOTOR POWER	15 kW
MOTOR RPM	1500

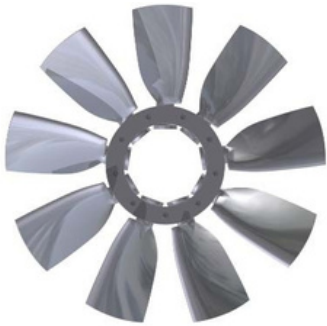

Model: 201112
 Demuro: 157928
 Tipo: Desplazamiento
 Unit: mm
 25.05.2016, 10:16:25
 1,726e008 Max

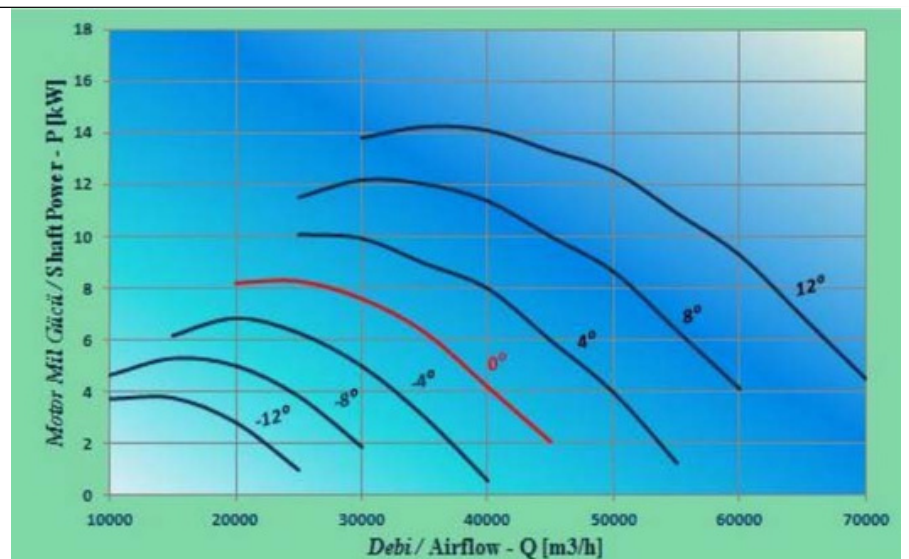
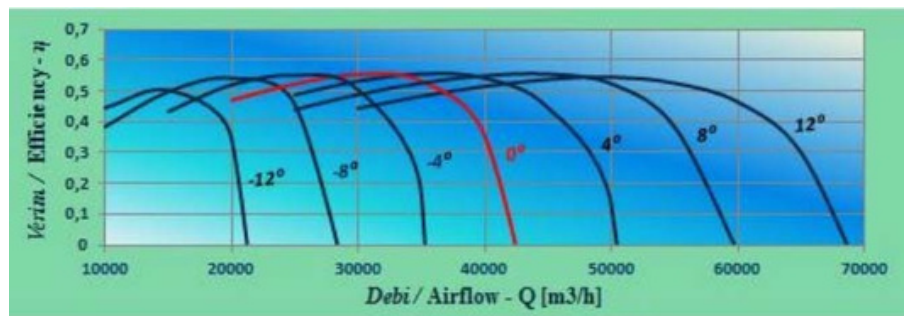
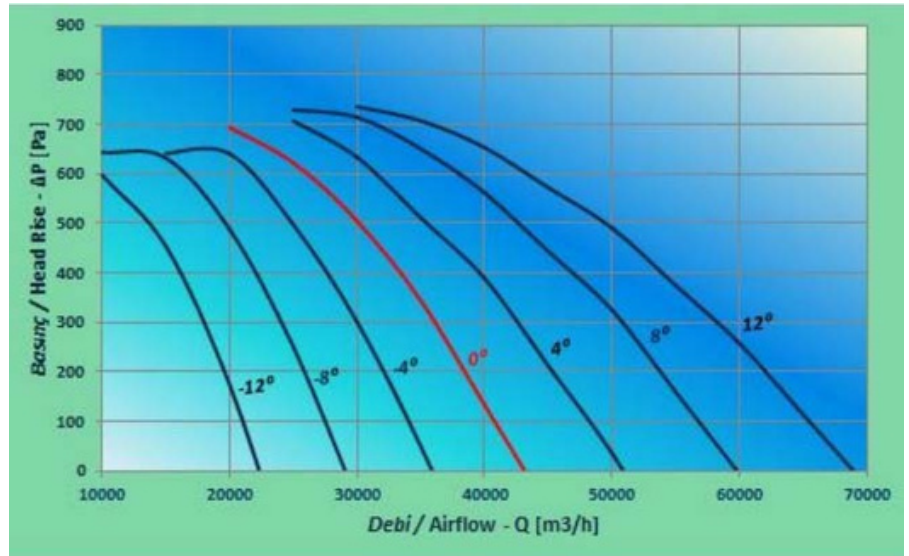
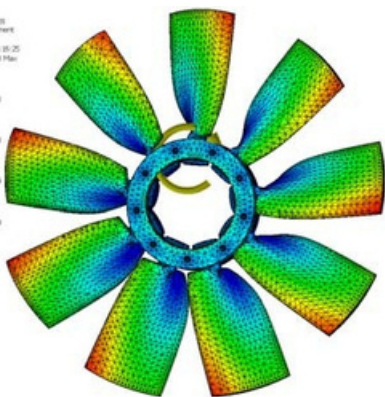
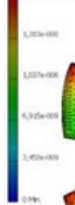

* ANSI/AMCA 210-07 standard is taken as reference in Fan Flow Performance tests.

* ISO 13347 standard was taken into account in the Noise Performance test.

AP-AF 1000 Technical Data

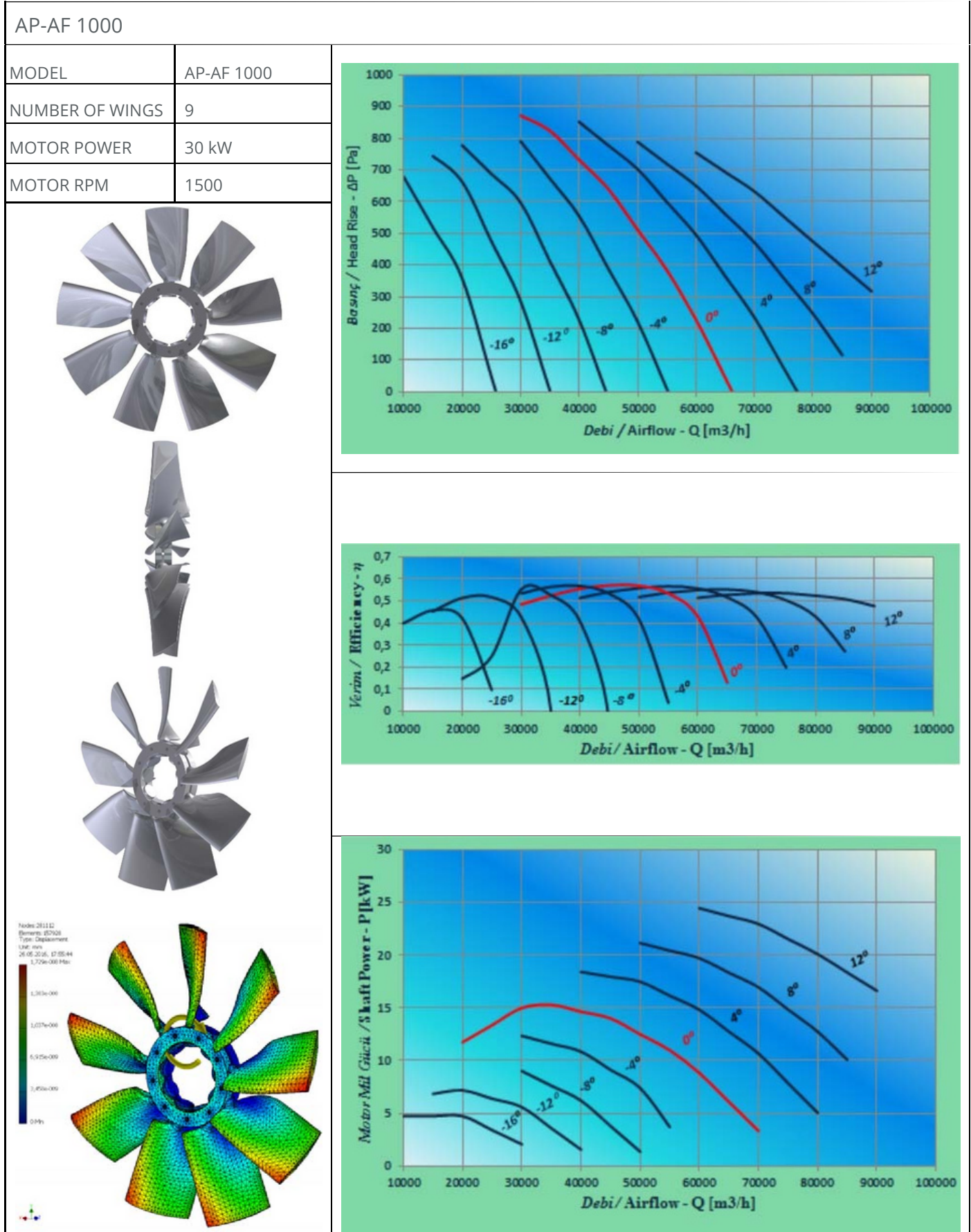

* ANSI/AMCA 210-07 standard is taken as reference in Fan Flow Performance tests.

* ISO 13347 standard was taken into account in the Noise Performance test.

AP-AF 1120 Technical Data

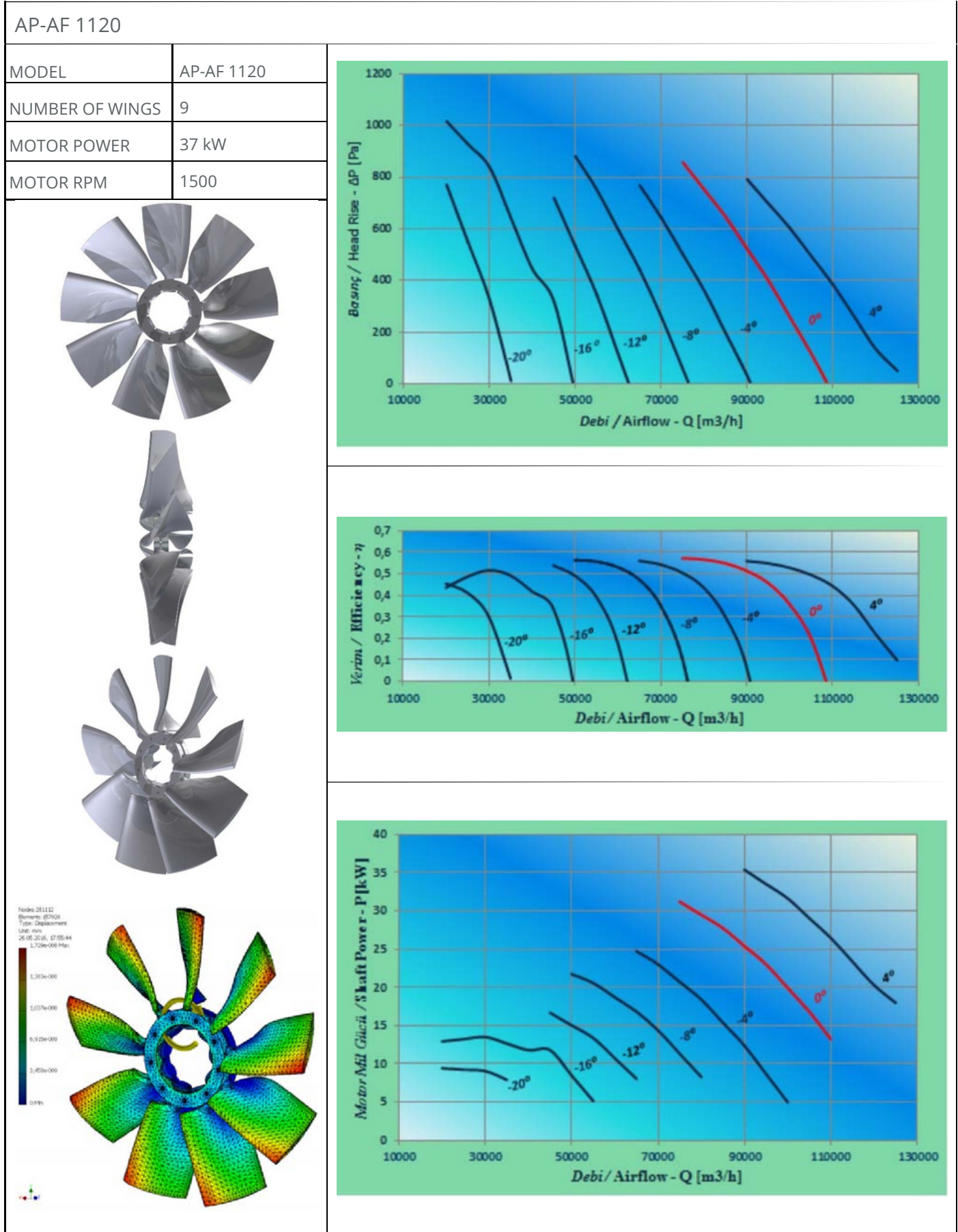

* ANSI/AMCA 210-07 standard is taken as reference in Fan Flow Performance tests.

* ISO 13347 standard was taken into account in the Noise Performance test.

AP-AF 1250 Technical Data

AP-AF 1250

MODEL	AP-AF 1250
NUMBER OF WINGS	9
MOTOR POWER	55 kW
MOTOR RPM	1500

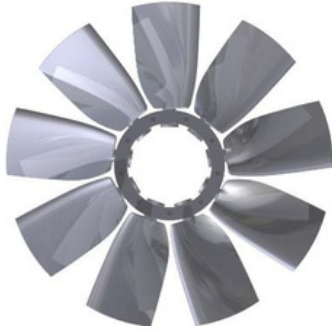

Model: 30112

Element: 172757

Type: Displacement

Unit: mm

26.05.2016, 17:50:26

1.307e-003 Pa

1.117e-000

6.381e-005

5.587e-005

2.794e-005

0 Pa

0 Pa

0 Pa

0 Pa

0 Pa

0 Pa

0 Pa

0 Pa

0 Pa

0 Pa

0 Pa

0 Pa

0 Pa

0 Pa

0 Pa

0 Pa

0 Pa

0 Pa

0 Pa

0 Pa

0 Pa

0 Pa

0 Pa

0 Pa

0 Pa

0 Pa

0 Pa



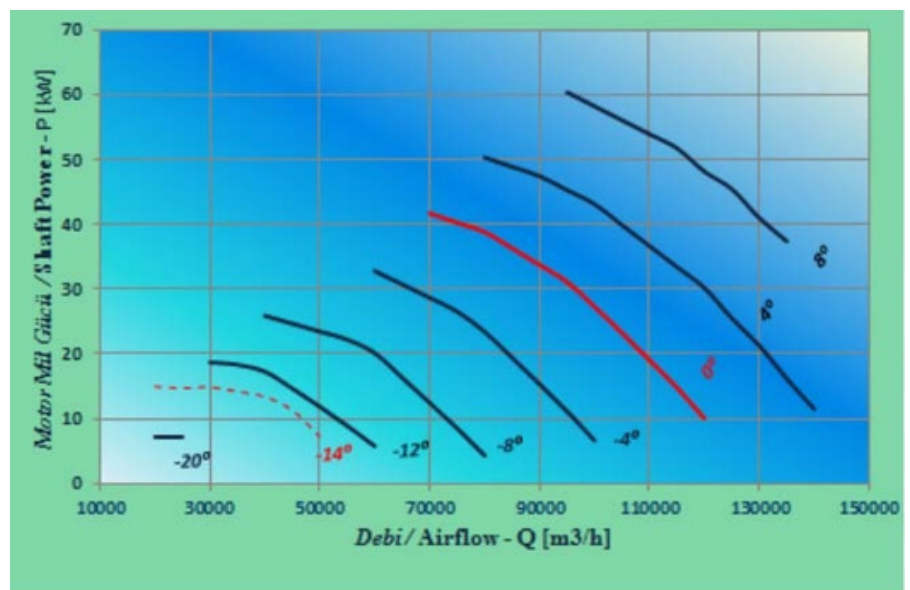
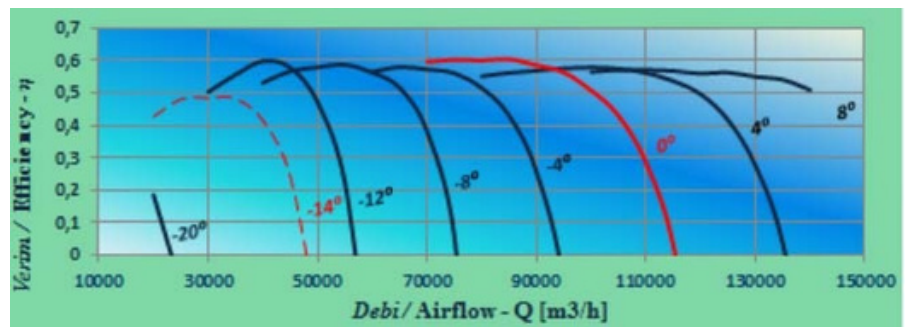
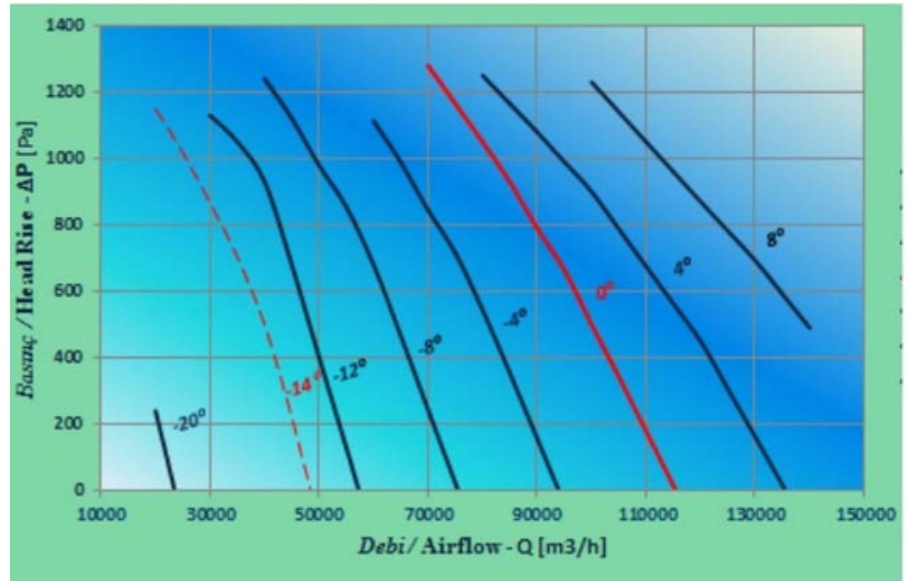
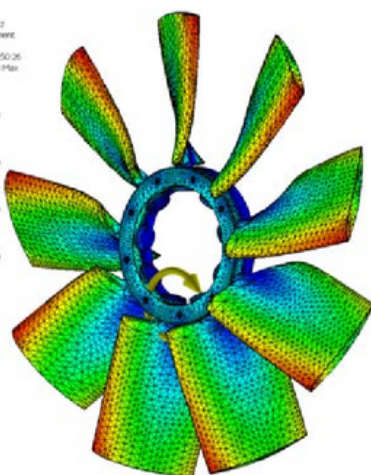

0 Pa

0 Pa

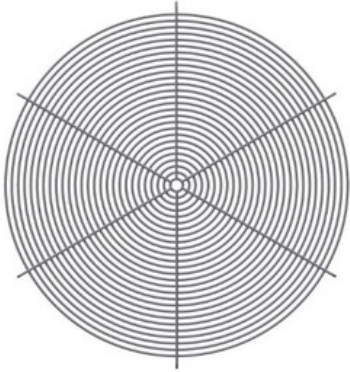

* ANSI/AMCA 210-07 standard is taken as reference in Fan Flow Performance tests.

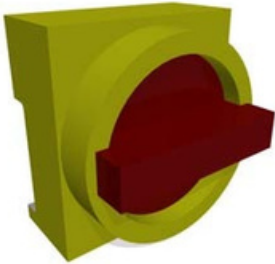
* ISO 13347 standard was taken into account in the Noise Performance test.

<p data-bbox="279 208 576 241">Protective Wire Mesh</p> 	<p data-bbox="1066 208 1257 241">Control Panel</p> 
<p data-bbox="228 667 667 701">Emergency Power Cut-off Switch</p> 	<p data-bbox="1043 667 1310 701">Frequency Inverter</p> 

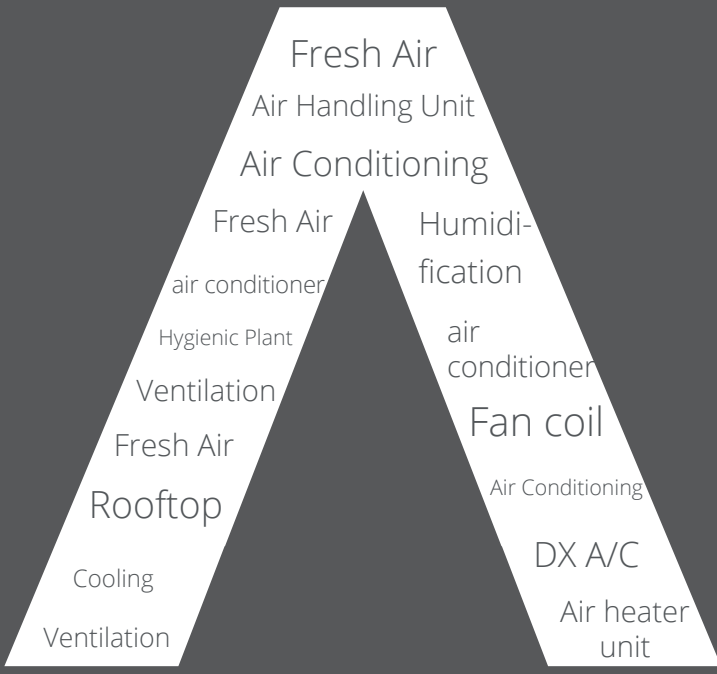

AIR+PLUS

Air Conditioning Technologies

Airplus İklimlendirme Teknolojileri San. Tic. Ltd. Şti

Sırapınar Mah.Beykoz Cad.Çanakçı Dere Mevki
No:99-3 Çekmeköy - İstanbul

Tel : +90 (216) 420 65 58
Faks : +90 (216) 420 65 59

www.airplus.com.tr

Revz. 09.23